



- very rugged
- two simultaneous channels
- reliable
- operating temperature up to +140°C
- inductive power supply
- high accuracy
- simple installation



2-CHANNEL-TELEMETRY SYSTEM

for strain gauge and temperature measurement on rotating parts

Telemetry System AXON J2DT

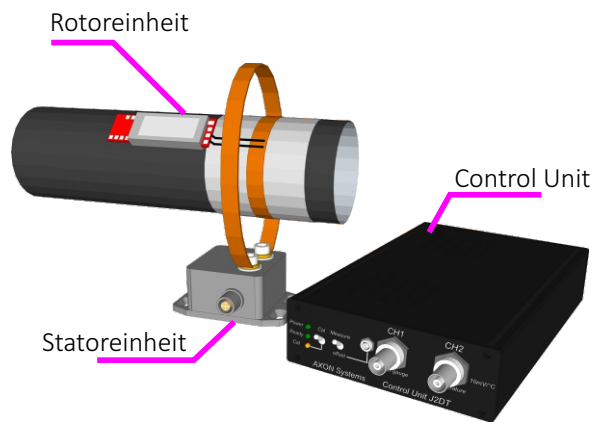

The telemetry system AXON J2DT transmits the signals of one strain gauge and one thermocouple at the same time. The amplified signals are made available on the Control Unit for further recording. The quality of the received digital data stream is constantly monitored, regulated and displayed via RSSI output. Thus, the telemetry system offers the possibility to simultaneously measure two sensor signals in the smallest space and transmit them contactless.

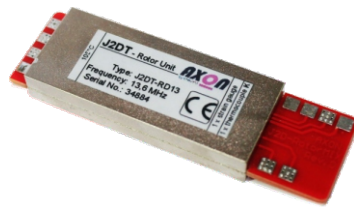

Rotor Unit:

Supplies the sensor with high-precision voltage, captures and processes the data from the strain gauge and transmits the fully digitised data stream contactless between the rotating shaft and the Stator Unit.



Control Unit:

The central control unit and data output of the telemetry system. Generates the inductive supply voltage for the rotor unit and reproduces the data measured on the shaft as a voltage signal. Inductive supply and RF data reception are monitored and always controlled during operation to ensure the best possible data transmission.



Stator Unit:

Produces the dynamic inductive field which supplies power to the Rotor Unit on the rotating shaft. Simultaneously it receives the digital data stream from the shaft. Distances up to 70mm between rotor and stator antenna can be realized. Axial and radial relative movements between stator and rotor are covered in an range of several centimeters⁽¹⁾.

(1) Depending on application

Funcional Principle

Telemetry System AXON J2DT

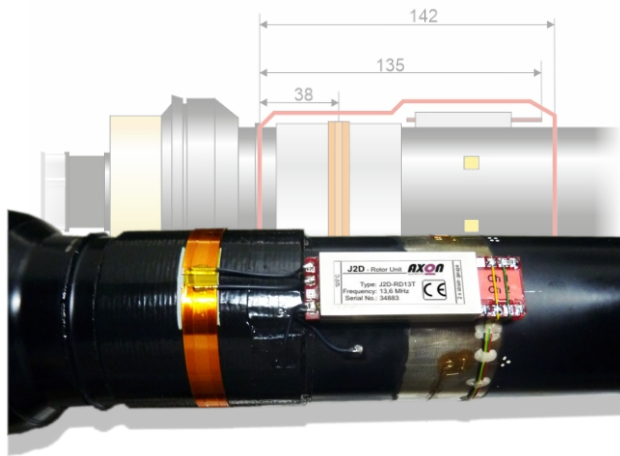

Measure strain and temperature on a rotating shaft at the same time!

The J2DT telemetry system is the perfect basis for highly professional combined strain gage- and temperature measurements that deliver stable and highly accurate measurement data, even under the toughest conditions.

Whether in vehicle testing or on the test bench- AXON telemetry systems deliver reliable measurement results under a wide variety of applications.

The highly effective inductive power supply of the rotating components allows an uninterrupted use even under harsh conditions.

Even in oil, a stable power- and data transmission is ensured.

The distance between the stator and rotor antenna can easily vary between 1 and 70mm⁽¹⁾.

The intelligent inductive power transmission IPT continuously optimizes the rotor supply voltage during operation.

In addition, the RSSI output⁽²⁾ of the Control Unit provides information about the quality of the received data stream.

1) Depending on application

2) Receive Signal Strength Indicator

Strain gauge and thermocouple based measurements on:

- Drive shafts
- Prop shafts
- Torque Flanges
- Rotating gearbox parts
- and many more



Telemetry System AXON J2DT

Rotoreinheiten

Specifications

Type	J2DT-RD13	J2DT-RD13T	J2DT-RD13H
Signal conditioning channel 1	Strain gauge full bridge		
Signal conditioning channel 2	Thermocouple type K (NiCrNi)		
Measurement range strain gauge	0,1 - 500 mV/V adjustable		
Measurement range thermocouple	-80 - +715°C		
Power supply	inductive or battery		
Modulation	PCM (digital)		
Resolution	12 bit (pure data stream)		
Sampling	5,2kSa/s per channel		
Housing	Aluminium		
Connections	Solder Pads		
Dimensions	65 x 19 x 7 mm		
Operating temperature	-40°C +105°C	-40°C +125°C	-40°C +140°C
Carrier frequency (standard)	13,6 MHz		
Carrier frequencies (optional)	12,6 MHz, 14,6 MHz, 15,6 MHz		
Weight	14 grams		
Degree of protection	IP67 with protectional covering of solder pads		
Conformity	CE		

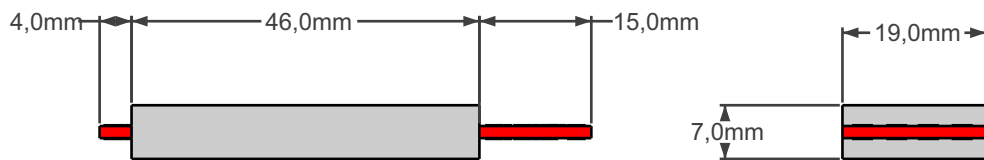
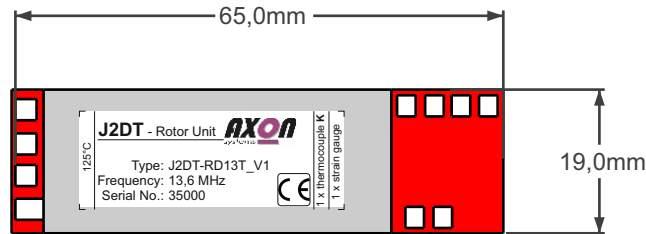

Accessories

J2D-RX-ADA

Adapter board for rotor unit J2D / J2DT with miniature screw terminals; flexible in the longitudinal direction; Dimensions: 71 x 20 x 61mm

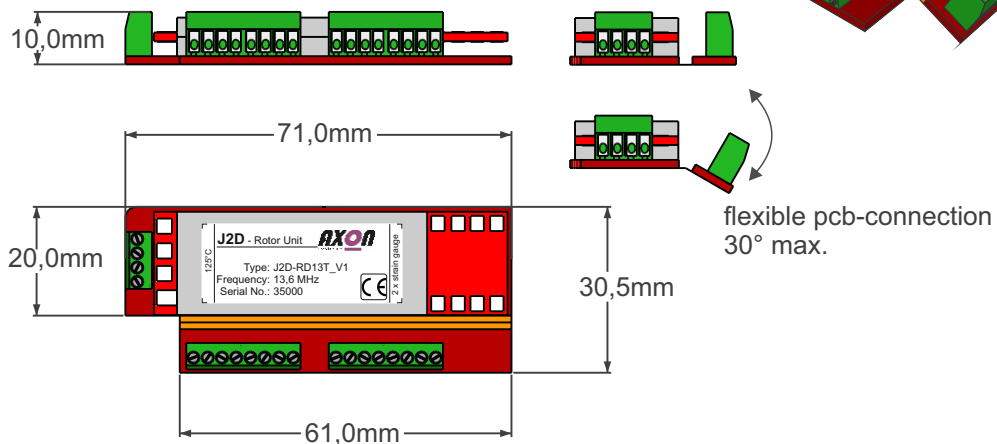
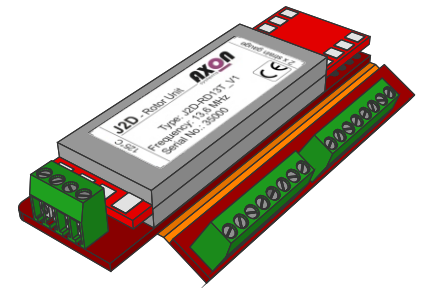

Telemetry System AXON J2DT

Stator Units

Standard-ringstator

Type	JXD-SR70	JXD-SR70T
Type of transmission	inductively with conductor loop (transmission coil)	
Transmission coil	copper free shapeable \varnothing 40 ... 1000mm	
Transmission distance	0 ... 70 mm ⁽¹⁾	
RF-Reception	wideband (10 MHz ... 30 MHz)	
Housing	Aluminium	
Connections	Fischer 4-pole, IP68	
Dimensions (incl. connections)	63 x 50 x 34,5 mm	
Operating temperature	-40°C ... +105°C	-40°C ... +125°C
Cable length Stator - Control Unit	5m; optional 7m, 8m, 10m, 30m, 50m any cable length up to 200m on request	
Weight	187 grams	
Degree of protection	IP68	
Conformity	CE	

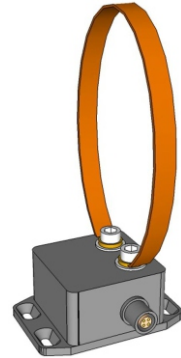

Ringstator for high EMC loaded environments

Type	JXD-SR70E	JXD-SR70TE
Type of transmission	inductively with conductor loop (transmission coil), additional EMC-terminal for signal analysis and suppression of disturbance fields	
Transmission coil	EMC-stator coil JX-ECE02 \varnothing 40 ... 1000mm	
Transmission distance	0 ... 70 mm ⁽¹⁾	
RF-Reception	wideband (10 MHz ... 30 MHz)	
Housing	Aluminium	
Connections	Fischer 4-pole, IP68	
Dimensions (incl. connections)	63 x 50 x 34,5 mm	
Operating temperature	-40°C ... +105°C	-40°C ... +125°C
Cable length Stator - Control Unit	5m; optional 7m, 8m, 10m, 30m, 50m any cable length up to 200m on request	
Weight	189 grams	
Degree of protection	IP68	
Conformity	CE	



Especially for use in vehicles
with electric drive and high
EMC load

(1) Depending on application

recommended accessory

JX-ECE02

Free shapeable transmission coil for stator units JX(D)-SR70(T)E with additional EMC-terminal.
Length 1m, shortenable

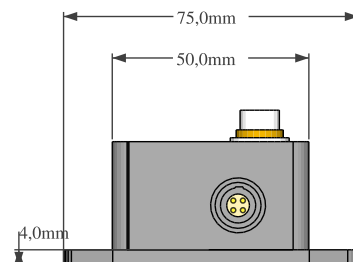
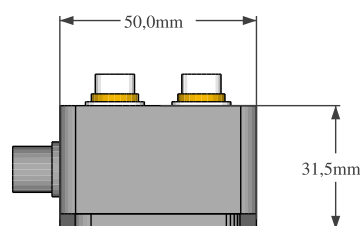
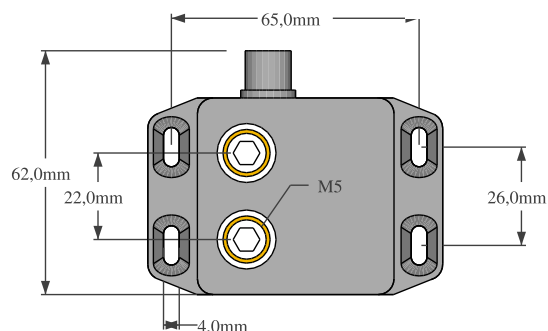

Specifications

Telemetry System AXON J2DT

Stator Units

Inductive-Stator without transmission coil

Typ	JXD-SE60	JXD-SE60T
Type of transmission	inductive as Pick-Up	
RF-Reception	wideband (10 MHz 30 MHz)	
Housing	Plastic	
Transmission distance	0 60 mm ⁽¹⁾	
Dimensions (without cable)	63 x 50 x 34,5mm	
Operating temperature	-40°C +105°C	-40°C +125°C
Cable length Stator - Control Unit	5m; optional 7m, 8m, 10m, 30m, 50m any cable length up to 200m on request	
Weight	220 grams	
Degree of protection	IP68	
Conformity	CE	

(1) Depending on application

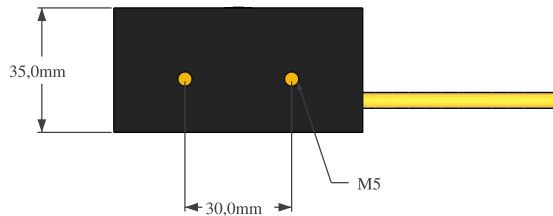
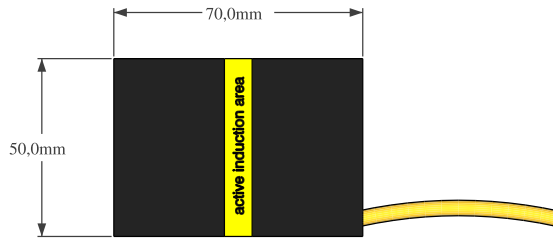

Specifications

Telemetry System AXON J2DT

Control Unit

Specifications

Type	J2DT-CE13
Dimensions	205 x 105 x 35mm (incl. connectors)
Supply voltage	9 - 36 VDC
Power consumption	app. 15 VA
Signal bandwidth	1000 Hz (-3dB)
Signal output 1: strain gauge	BNC; analog Voltage $\pm 10V$
Signal output 2: thermo.	BNC; voltage -0,8 ... 7,15V; 10mV/°C linearised
Carrier frequency (standard)	13,6 MHz
Carrier frequency (optional)	12,6 MHz, 14,6 MHz, 15,6 MHz
Offset correction	$\pm 0,5V$, by Poti
Signal propagation delay	450 μs
Wireless shunt cal	Shunt Cal push button on Control Unit
Degree of protection	IP40
Weight	app. 450 grams
Operating temperature	-20°C - +75°C
Overvoltage protection	integrated
Reverse polarity protection	integrated
RSSI-Output ⁽¹⁾	0 - 4,5 VDC
Conformity	CE

(1) Receive Signal Strength Indicator

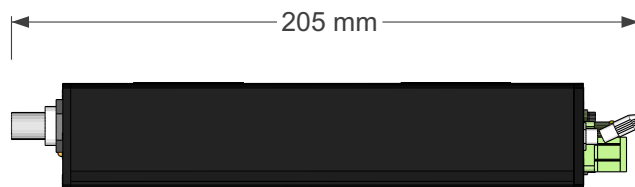
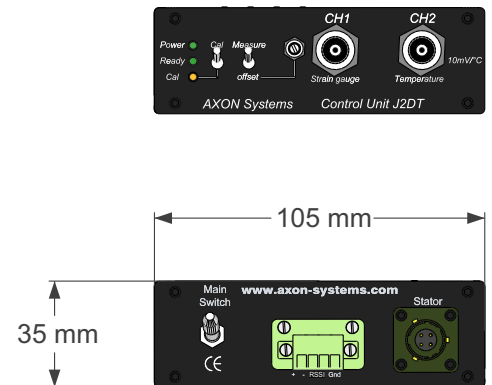
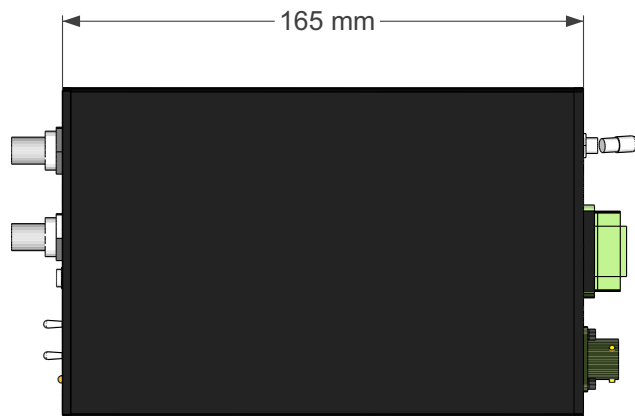
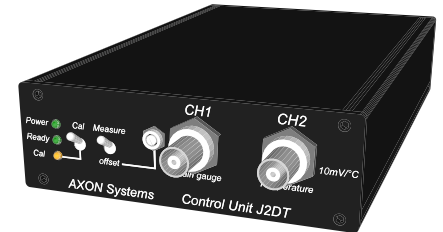

The product is in compliance with the requirements of the following European directive:

199/5/EC Radio and Telecommunications Terminal Equipment (R&TTE)

2011/65/EU Restriction of the use of certain hazardous substances in electrical and electronic equipment (RoHS)

The compliance with the requirements of the European Directive was proved by the application of the following harmonized standards:

R&TTE: EN 300 330-2 V1.5.1
EN 301 489-1 V1.9.2
EN 301 489-3 V1.6.1
EN 50364:2010
EN 55011:2009+A1:2010
EN 60950-1:2006 + A11:2009 + A12:2011 + A1:2010 + A2:2013
RoHS: EN 50581:2012

The object of the declaration described above is in conformity with Directive 2011/65/EU of the European Parliament and of the Council of 8 June 2011 on the restriction of the use of certain hazardous substances in electrical and electronic equipment.

Telemetry System AXON J2DT

AXON „J“-series telemetry systems as an overview

- AXON J1
robust 1-channel telemetry system
for strain gauge measurements,
analogue transmission

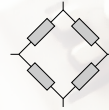

- AXON J1DB
digital 1-channel telemetry system
for strain gauge measurements with
monitoring of the rotor power supply

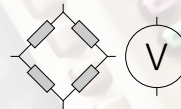

- AXON J2D
digital 2-channel telemetry system for
the simultaneous transmission of two
strain gauge signals

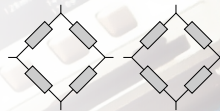

- AXON J2DT
digital 2-channel telemetry system for
the simultaneous transmission of one
strain gauge and one thermocouple signal



- AXON J1T
digital 1-channel telemetry system for
the transmission of one thermocouple
signal



- AXON J2T
digital 2-channel telemetry system for
the simultaneous transmission of two
thermocouple signals



- AXON J4T
digital 4-channel telemetry system for
the simultaneous transmission of four
thermocouple signals



- AXON J8T
digital 8-channel telemetry system for
the simultaneous transmission of eight
thermocouple signals



Applications

Telemetry System AXON J2DT

Shaft applications for torque- and temperature measurements
planned in detail - professionally built - delivered quickly

Another focus of AXON is the production of customized torque- and temperature measurement shafts. Careful planning includes the preparation of release drawings, which allow the user to check all dimensions and details for execution.

The flexibility of the AXON telemetry systems enables the construction of measuring shafts that work in the most difficult space conditions.

Sensors and electronics are sealed in multiple layers. A high-strength glass fiber composite protects the application from water, oil and mechanical damage. Thus, the maintenance-free applications are ideally suited for long-term driving tests.

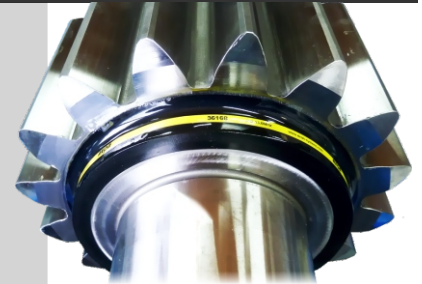

State-of-the-art technology
in a robust package

The flexible design options
of the AXON telemetry
systems allow countless
application variants.

- Telemetry
- Application
- Calibration

from one source
fast and reliable

**From development to
customized solutions -
all from one hand**

- Development and production
- Application of measurement shafts
- Strain gauge application and calibration



Whether by phone, e-mail or in person - our support is always available for questions about our systems - fast and easy!

Our experienced engineers and technicians will be happy to assist you in planning your measurement tasks - contact us!

Contents and illustrations of this datasheet have been elaborated to the best of our knowledge and with utmost diligence we reserve the right of error and technical modifications.